



Panasonic®

LCD TV Operating Instructions

Model No. **TC-20LA2**
TC-20LA2D



LCD TV shown above is model TC-20LA2.

For assistance, please call : 1-800-211-PANA (7262)
or send e-mail to : consumerproducts@panasonic.com
or visit us at www.panasonic.com (U.S.A)

For assistance, please call : 787-750-4300
or visit us at www.panasonic.com (Puerto Rico)

For assistance, please call : 1-800-561-5505
or visit us at www.panasonic.ca (Canada)

Before connecting, operating or adjusting this product, please read these instructions completely.
Please keep this manual for future reference.

English

Español [Resumen]

TQBC0758

Important Safety Instructions



The lightning flash with arrow head within a triangle is intended to tell the user that parts inside the product are a risk of electric shock to persons.



The exclamation point within a triangle is intended to tell the user that important operating and servicing instructions are in the papers with the appliance.

■ **Note to CATV System Installer:** This reminder is provided to direct the CATV system installer's attention to Article 820-40 of the NEC that provides guidelines for proper grounding and, in particular, specifies that the cable ground shall be connected to the grounding system of the building, as close to the point of cable entry as practical.

■ Important Safety Instructions for LCD TV

- 1) Read these instructions. All the safety and operating instructions should be read before the appliance is operated.
- 2) Keep these instructions.
- 3) Heed all warnings.
- 4) Follow all instructions.
- 5) Do not use this apparatus near water. For example: Avoid placing it near a bathtub, washbowl, kitchen sink, or laundry tub, in a wet basement, or near a swimming pool, etc.
- 6) Clean only with dry cloth. Unplug this LCD TV from the wall outlet before cleaning. Do not use liquid or aerosol cleaners.
- 7) Do not block any ventilation openings. Install in accordance with the manufacturer's instructions. Slots and openings in the cabinet and the back or bottom are provided for ventilation, and to ensure reliable operation of the LCD TV and to protect it from overheating. These openings must not be blocked or covered. There should be at least 10 cm of space from these openings. The openings should never be blocked by placing the LCD TV on a bed, sofa, rug or other similar surface. This LCD TV should not be placed in a built-in installation such as a bookcase unless proper ventilation is provided.
- 8) Do not install near any heat sources such as radiators, heat registers, stoves, or other apparatus (including amplifiers) that produce heat.
- 9) Do not defeat the safety purpose of the polarized or grounding-type plug. A polarized plug has two blades with one wider than the other. A grounding type plug has two blades and a third grounding prong. The wide blade or the third prong are provided for your safety. If the provided plug does not fit into your outlet, consult an electrician for replacement of the obsolete outlet.
- 10) Protect the power cord from being walked on or pinched particularly at plugs, convenience receptacles, and the point where they exit from the apparatus.
- 11) Only use attachments/accessories specified by the manufacturer. Otherwise it may cause hazards.
- 12) Use only with the cart, stand, tripod, bracket, or table specified by the manufacturer, or sold with the apparatus. When a cart is used, use caution when moving the cart/apparatus combination to avoid injury from tip-over.
- 13) Unplug this apparatus during lightning storms or when unused for long periods of time. This will prevent damage to the receiver due to lightning and power-line surges.
- 14) Refer all servicing to qualified service personnel. Servicing is required when the apparatus has been damaged in any way, such as power-supply cord or plug is damaged, liquid has been spilled or objects have fallen into the apparatus, the apparatus has been exposed to rain or moisture, does not operate normally, or has been dropped.
Upon completion of any service or repairs to this LCD TV, ask the service technician to perform routine safety checks to determine that the television is in safe operating condition.
- 15) Operate only from the type of power source indicated on the marking label. If you are not sure of the type of power supplied to your home consult your television dealer or local power company.
- 16) Follow all warnings and instructions marked on the LCD TV.
- 17) Never push objects of any kind into this LCD TV through cabinet slots as they may touch dangerous voltage points or short out parts that could result in a fire or electric shock. Never spill liquid of any kind on the LCD TV.



Important Safety Instructions

18) If an outside antenna is connected to the television equipment, be sure the antenna system is grounded so as to provide some protection against voltage surges and built up static charges. In the U.S. Selection 810-21 of the National Electrical Code provides information with respect to proper grounding of the mast and supporting structure, grounding of the lead-in wire to an antenna discharge unit, size of grounding conductors, location of antenna discharge unit, connection to grounding electrodes, and requirements for the grounding electrode.

19) An outside antenna system should not be located in the vicinity of overhead power lines or other electric light or power circuits, or where it can fall into such power lines or circuits. When installing an outside antenna system extreme care should be taken to keep from touching such power lines or circuits as contact with them might be fatal.

20) Unplug this LCD TV from the wall outlet, and refer servicing to qualified service personnel under the following conditions:

- When the power cord or plug is damaged or frayed.
- If liquid has been spilled into the LCD TV.
- If the LCD TV has been exposed to rain or water.
- If the LCD TV does not operate normally by following the operating instructions.

Adjust only those controls that are covered by the operating instructions as improper adjustment of other controls may result in damage and will often require extensive work by a qualified technician to restore the LCD TV to normal operation.

e. If the LCD TV has been dropped or the cabinet has been damaged.

f. When the LCD TV exhibits a distinct change in performance - this indicates a need for service.

21) When replacement parts are required, be sure the service technician to use replacement parts specified by the manufacturer that have the same characteristics as the original part. Unauthorized substitutions may result in fire, electric shock, or other hazards.

22) **WARNING: TO REDUCE THE RISK OF FIRE OR ELECTRIC SHOCK, DO NOT EXPOSE THIS APPARATUS TO RAIN OR MOISTURE.**

DO NOT PLACE LIQUID CONTAINERS (FLOWER VASES, CUPS, COSMETICS, ETC.) ABOVE THE SET. (INCLUDING ON SHELVES ABOVE, ETC.)

23) **CAUTION: TO PREVENT ELECTRIC SHOCK DO NOT USE THIS PLUG WITH A RECEPTACLE OR OTHER OUTLET UNLESS THE BLADES CAN BE FULLY INSERTED TO PREVENT BLADE EXPOSURE.**

24) **CAUTION: USE WITH OTHER STAND MAY RESULT IN INSTABILITY CAUSING POSSIBLE INJURY.**

25) **CAUTION: DANGER OF EXPLOSION IF BATTERY IS INCORRECTLY REPLACED. REPLACE ONLY WITH THE SAME OR EQUIVALENT TYPE.**

EXAMPLE OF ANTENNA GROUNDING AS PER (NEC) NATIONAL ELECTRICAL CODE

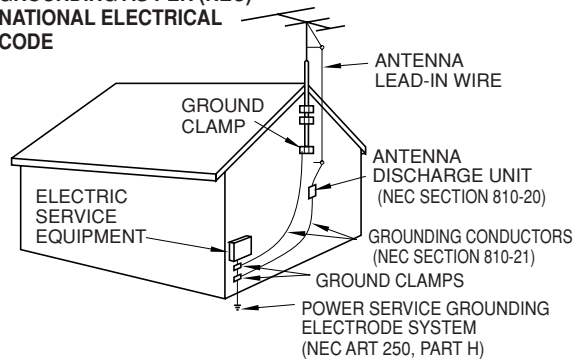

NOTE: ● This equipment is designed to operate in the U.S.A. and other countries where the broadcasting system and AC house current is exactly the same as in the U.S.A.

- The marking or retained image on the LCD panel resulting from fixed image use is not an operating defect and as such is not covered by Warranty. This product is not designed to display fixed image patterns for extended periods of time.

■ Important Information Regarding Use of Video Games, Computers, Captions or Other Fixed Image Displays.

The extended use of fixed image program material can cause a permanent "shadow image" on the LCD panel. This background image is viewable on normal programs in the form of a stationary fixed image. This type of irreversible LCD panel deterioration can be limited by observing the following steps:

- Reduce the brightness/contrast setting to a minimum viewing level.
- Do not display the fixed image for extended periods of time.
- Turn the power off when not in actual use.

■ This product utilizes tin-lead solder, and has a fluorescent lamp containing a small amount of mercury. Disposal of these materials may be regulated in your community due to environmental considerations. For disposal or recycling information please contact your local authorities, or the Electronics Industries Alliance: www.eiae.org.

Dear Panasonic Customer

Welcome to the Panasonic family of customers.

We hope that you will have many years of enjoyment from your new LCD TV.

To obtain maximum benefit from your set, please read these instructions before making any adjustments, and retain them for future reference.

Retain your purchase receipt, and record the model number and serial number of your set in the space provided on the rear cover of these instructions.

For assistance, please call : 1-800-211-PANA (7262) or send e-mail to : consumerproducts@panasonic.com or visit us at www.panasonic.com (U.S.A.)
For assistance, please call : 787-750-4300 or visit us at www.panasonic.com (Puerto Rico)
For assistance, please call : 1-800-561-5505 or visit us at www.panasonic.ca (Canada)

Federal Communication Commission Information

This equipment has been tested and found to comply with the limits for a TV Broadcast Receiver, pursuant to Part 15 of the FCC Rules. These limits are designed to provide reasonable protection against harmful interference in a residential installation. This equipment generates, uses and can radiate radio frequency energy and, if not installed and used in accordance with the instructions, may cause harmful interference to radio communications. If this equipment does cause or receive interference, which can be determined by turning equipment off and on, the user is encouraged to try to correct the interference by one of the following measures:

- Reorient or relocate the TV antenna.
- Increase the separation between TV and other equipment.
- Connect TV into separate outlet from other equipment.
- Consult the dealer or an experienced radio/TV technician for help.

FCC Caution: Any changes or modifications not expressly approved by the party responsible for compliance could void the user's authority to operate this equipment.



The Energy Star label, a symbol for energy efficiency, was created by the U.S. Environmental Protection Agency (EPA) and the U.S. Department of Energy (DOE) to help customers identify products that can save them money and protect the environment by saving energy. Energy Star compliant products generally consume less energy than similar standard products.

Installation

View Location

... for comfortable viewing. Avoid ...
... the screen.

... of some types of fluorescent light ...
... adequate ventilation is essential to pre ...
... or moisture.

Optional External Equipment

... Video/Audio connection between ...
... performance, Antenna cables sh ...
... dealer or electronic supply store ...
... before you purchase any cables, be ...
... components require. Also determine

Optimum quality picture

... when the LCD is exposed to light from ...
... early. Turn off florescent lamps near

How to use the LCD stand

... just the stand to your desired ang

TC-20LA2

The stand angle can be adjusted b



• TC-20LA2D

The stand angle is fixed 14° ba



Maintenance

To clean this unit, wipe with a soft, dry cloth.

If the surfaces are extremely dirty, use a soft cloth dipped in a soap and water solution or a weak detergent solution.

- Use eyeglass cleaner to remove stubborn dirt from the LCD.
- Never use alcohol, paint thinner or benzine to clean this unit.
- Before using a chemically treated cloth, read the instructions that came with the cloth carefully.

CAUTION :

If water or similar substances get inside the monitor via the liquid crystal panel surface, a malfunction may result.

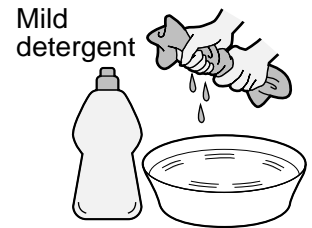

Connections

Note:

Cables and adapters are not supplied with this set.

Antenna Connection

For proper reception of VHF/UHF channels, an external antenna is required. For best reception, an outdoor antenna is recommended. The antenna mode must be set to TV (see page 16, MODE).

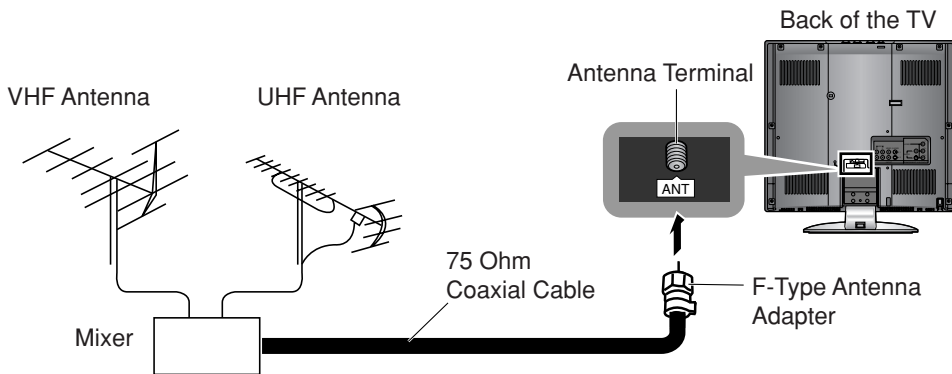

■ Antenna / Cable Connection

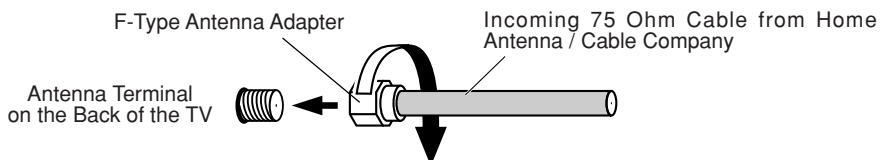

Cable Box

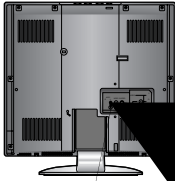

Cable Box and VCR

Connecting Other Equipment

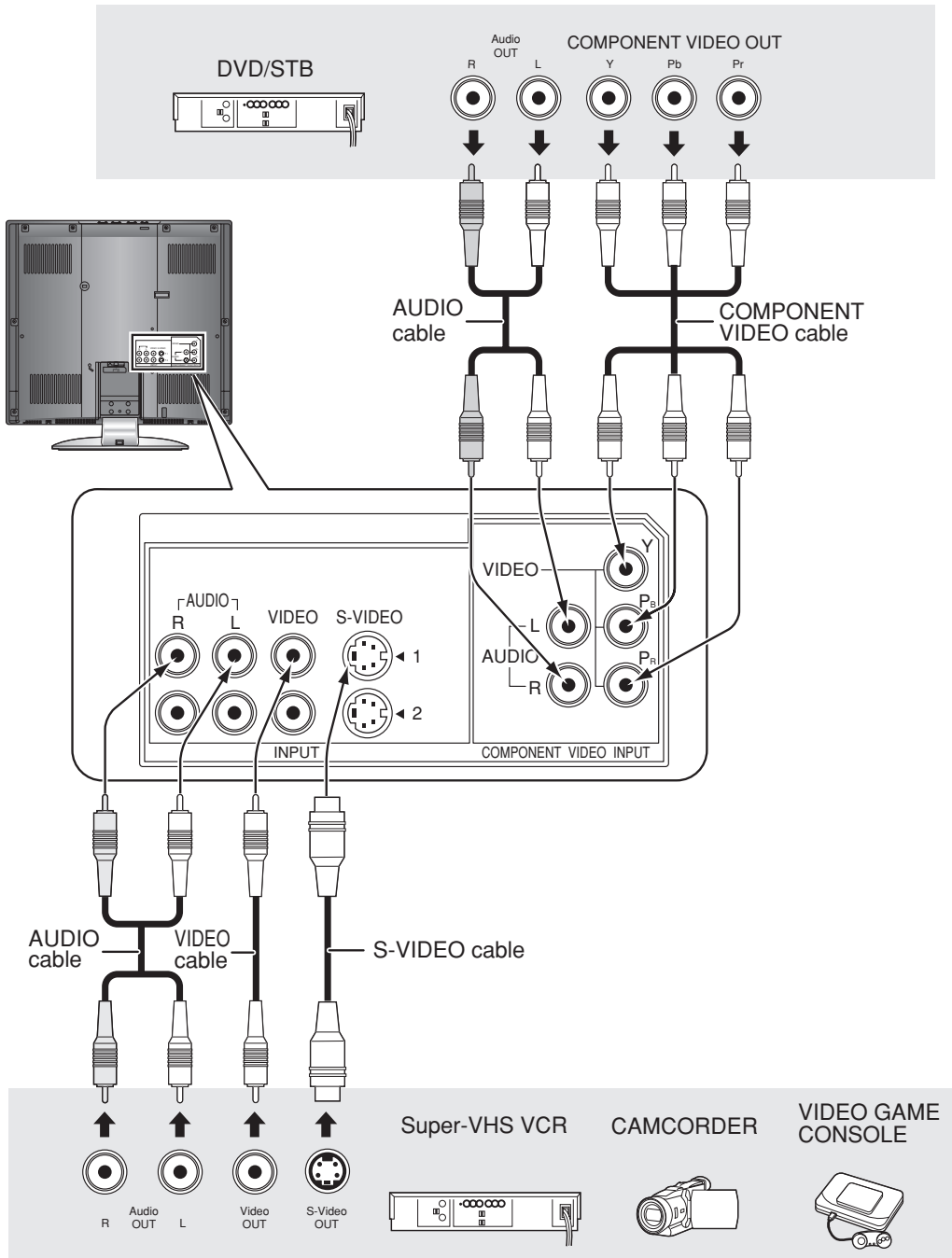

Notes:

- Only 480i and 480p are available through the component input terminals.
- When connecting video cables, priority is given to the S-Video cable when both the S-VIDEO input terminal and the VIDEO input terminal are connected.
- With a monaural VCR, connect the monaural audio cable to the AUDIO-L terminal.
- Please make inquiries to video game manufacturers concerning component cables to connect with video game console.

■ To bundle the cables with the clumper

[TC-20LA2]

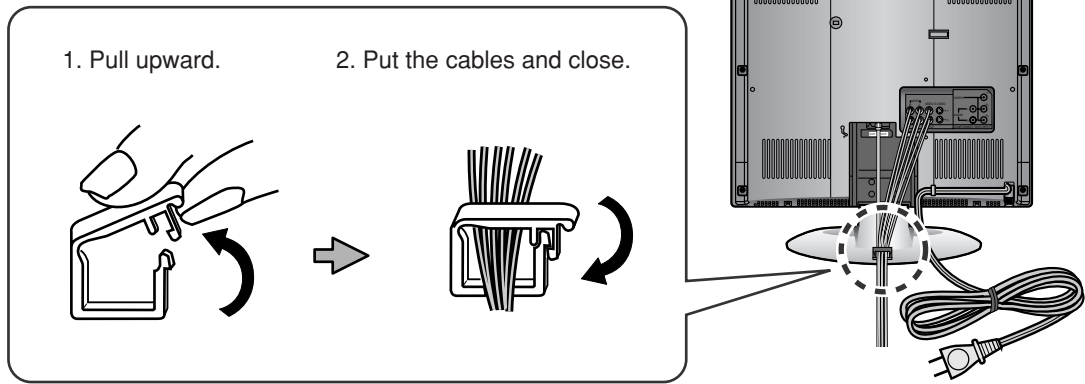

Note:

- Do not put the antenna cable and the power cord together to avoid noise.

Connecting Headphones / Earphones

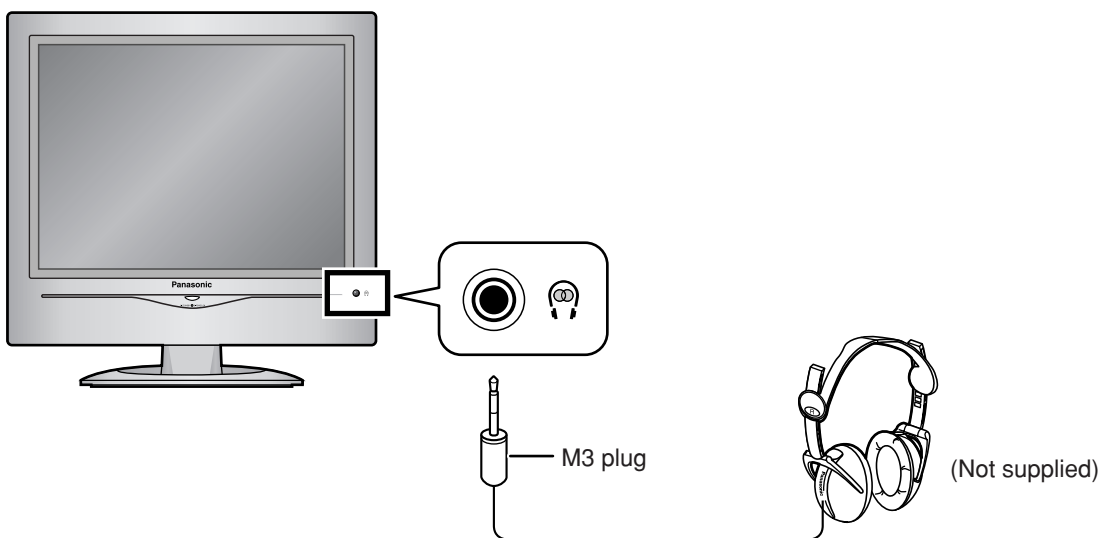

Power ON / OFF

Connecting the Plug to the Wall Outlet

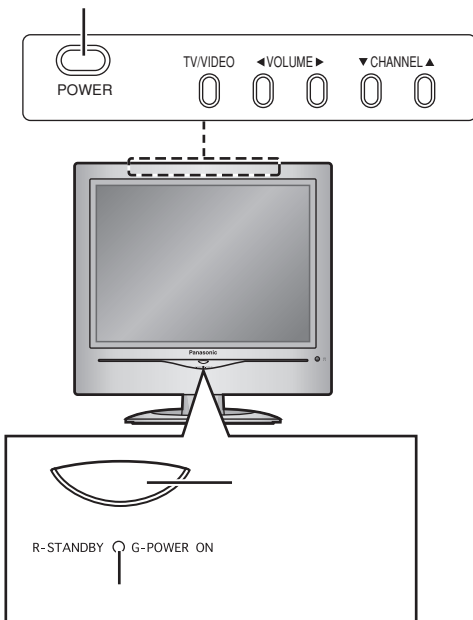
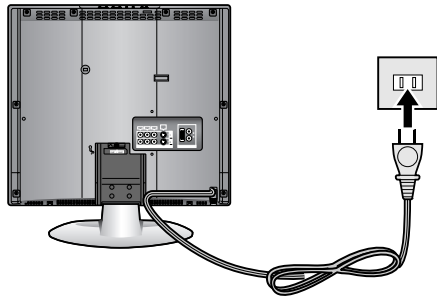

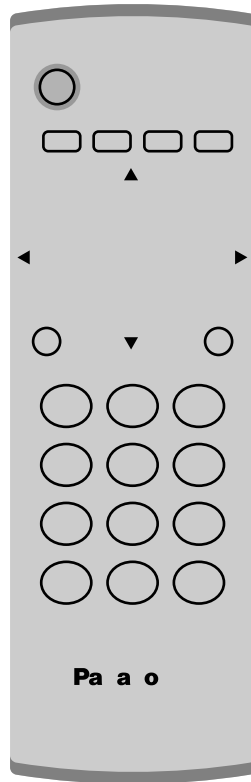
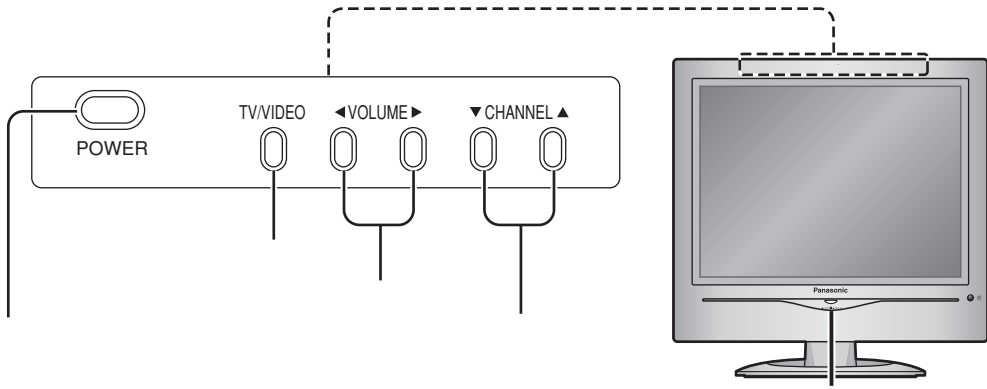



1

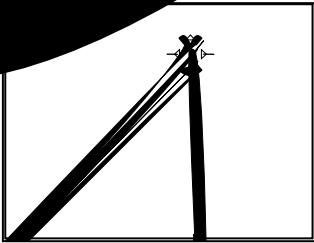
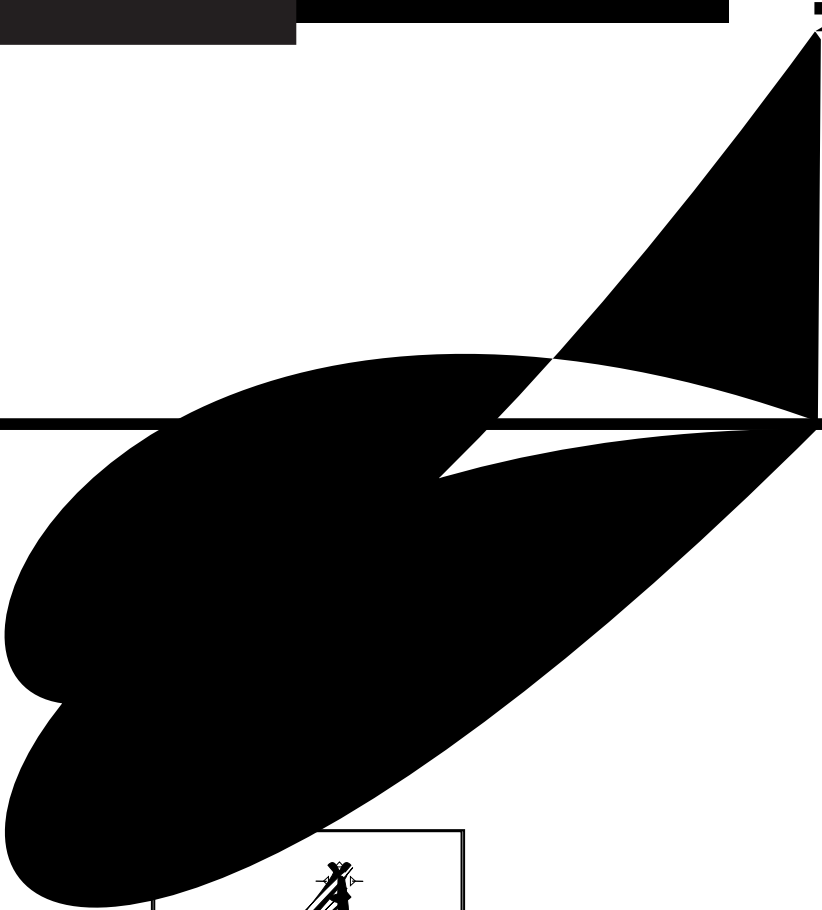
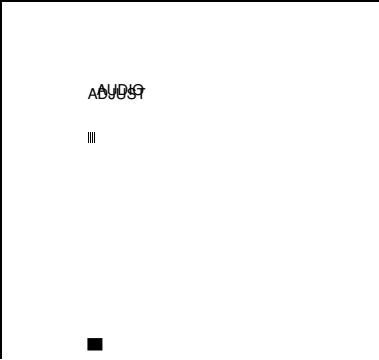
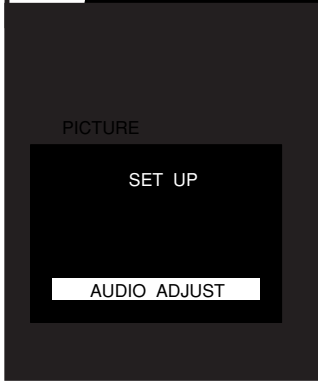

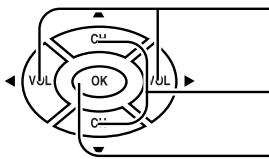

Press to select the MENU screen (ADJUST or SET UP).

Press to select the sub-menu feature.

Press to display the sub-menu screen.

● To return to the previous screen : RETURN

● To exit the MENU screen: MENU This returns to the normal viewing.

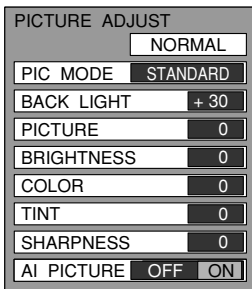

(See page 24)

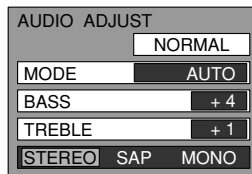

(See page 25)



Select the menu language.

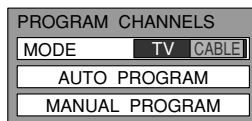
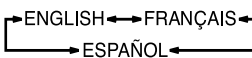

(See pages 16,17)

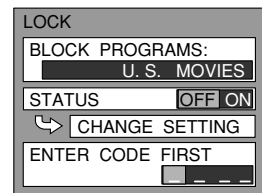

(See page 18 - 21)

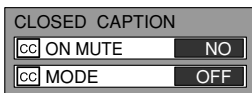

(See page 22)

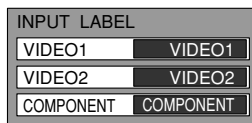

(See page 23)

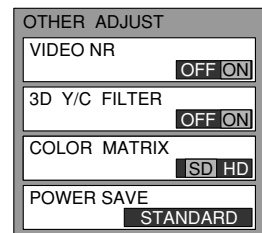

(See page 23)

Tuning Channels

2

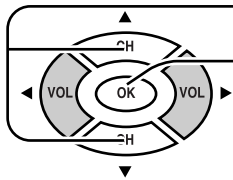

Press to select PROGRAM CH.
Press to display the PROGRAM CHANNELS screen.

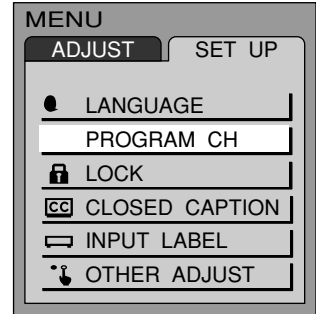

3

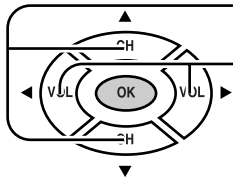

Press to select MODE.
Press to select TV or CABLE.

Automatically scans and stores all the TV channels.

4

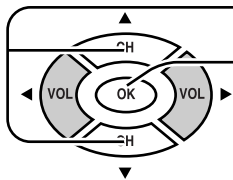

Press to select AUTO PROGRAM.
Press to display the AUTO PROGRAM screen.

5

Press to select YES.

Press to start AUTO PROGRAM.

Channels will automatically advance until all channels have been scanned. Channel numbers with video signal received will be stored in the Channel Memory.

Notes:

- When any button is pressed during AUTO PROGRAM, the TV will return to the normal viewing. (Channels searched up to the point are added.)
- After AUTO PROGRAM finishes, the lowest channel number added will be displayed.
- When there are no receivable channels, channel 69 (for TV) or channel 125 (for cable TV) is displayed.

Manual channel programming

Add or delete a channel manually.

4

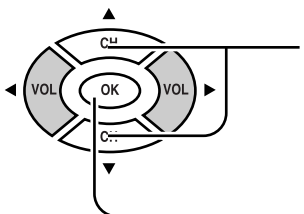

Press to select MANUAL PROGRAM.

Press to display the MANUAL PROGRAM screen.

PROGRAM CHANNELS	
MODE	TV CABLE
AUTO PROGRAM	
MANUAL PROGRAM	

MANUAL PROGRAM
ENTER CHANNEL
121

5

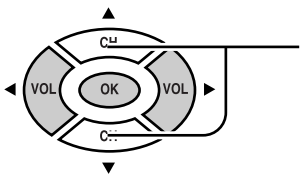

Press to select the channel.

- You can also use the numbered buttons.

6

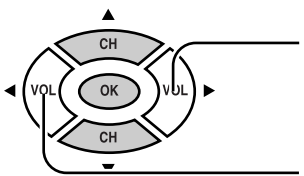

Press to add the channel to the Channel Memory (the channel number turns blue).

Press to delete the channel from the Channel Memory (the channel number turns yellow).

- Repeat steps 5 and 6 for other channels.

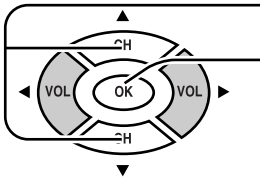

LOCK

In the United States, the V-CHIP consists of two rating systems, which are MPAA (MOTION PICTURE) and TV PARENTAL GUIDELINES. Its function is to block programs by the rating data in the XDS data packets sent from broadcasting stations. The user can select which rating programs should be blocked by the LOCK MENU options.

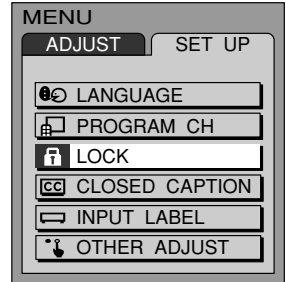
1  Press to select LOCK.
Press to display the LOCK screen.



2  Input 4-digit code.

- To clear the numbers while entering the code, press Up  or Down .
- You will need the code to enter the LOCK menu.
- After entering your password for the first time, ENTER CODE FIRST will change to CHANGE CODE.

Note:

Use a code that is easy to remember and record it in a safe place.

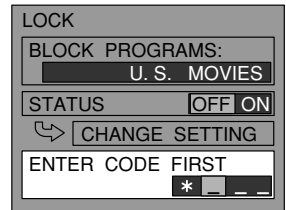

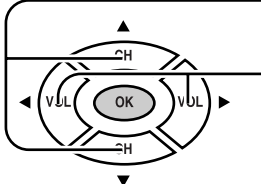
3  Press to select BLOCK PROGRAMS.
Press to select U.S. MOVIES, U.S. TV PROGRAMS, CANADIAN ENGLISH or CANADIAN FRENCH.

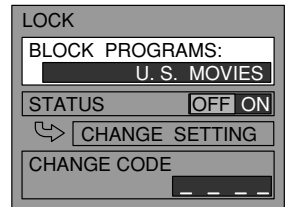

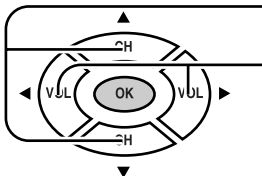
4  Press to select STATUS.
Press to select ON or OFF.

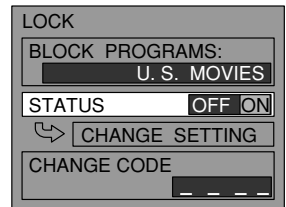

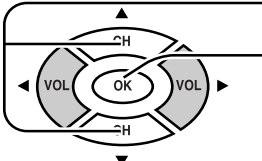
5  Press to select CHANGE SETTING.
Press to enter the next menu.

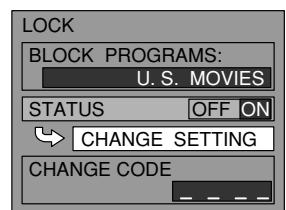

U.S. TV PROGRAM

6

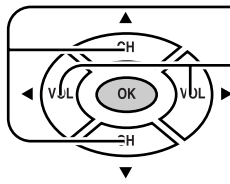

Press to select VIEW NR PROGRAMS?.

Press to select NO or YES.

NO : Cannot view programs with NR signals.
YES : Can view programs with NR signal.

7

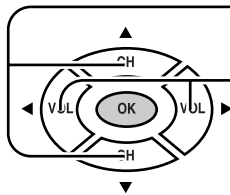

Press to select SETTING.

Press to select BASIC or DETAILED.

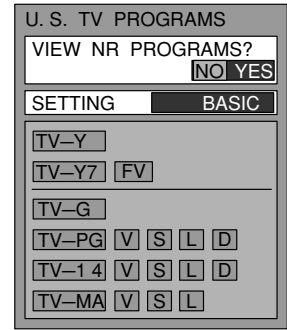

Title Option

8

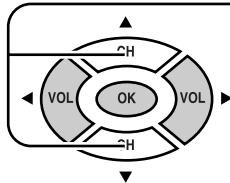

Press to select the rating.

BASIC : You can select the titles.

DETAILED : You can select the titles and options.

- When a title field is selected, all ratings below this rating are selected.
When options within an option field are selected, ratings below this rating within the same field are selected.

9

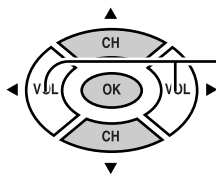

Press to lock or unlock the rating.

Lock : Red

Unlock : Green

Rating

1. Ratings for children: Divided into ranks as follows.

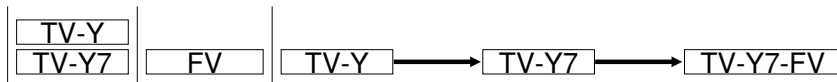

2. Ratings for teenagers: Created out of these major categories to form various combinations. These combinations are described in the below diagram. Ratings for all ages are on top and ratings for adults are on the bottom.

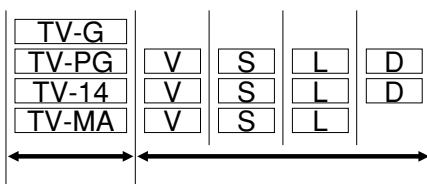

Menu Operations

U.S. MOVIES

6

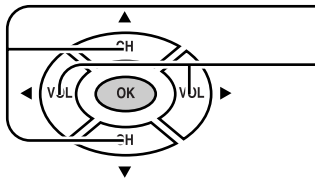

Press to select VIEW NR PROGRAMS?.

Press to select NO or YES.

NO : Cannot view programs with NR signals.
YES : Can view programs with NR signals.

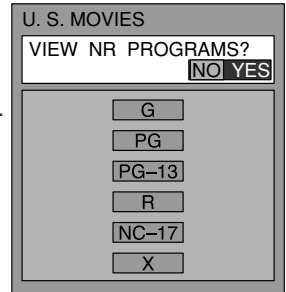

7

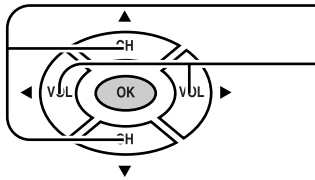

Press to select the rating.

Press to lock or unlock the rating.

Lock : Red

Unlock : Green

Rating

G : General audience

PG : Parental guidance suggested

PG-13 : Parental guidance needed
under 13 years old

R : Restricted

NC-17 : No one under 17 is admitted

X : Pornography

CANADIAN ENGLISH / CANADIAN FRENCH

6

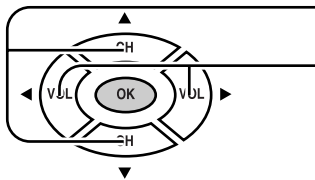

Press to select VIEW E PROGRAMS?.

Press to select NO or YES.

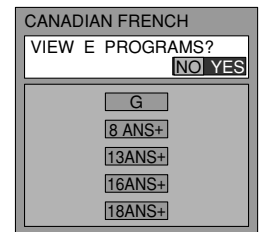
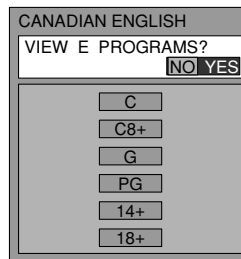

7

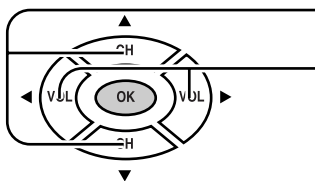

Press to select the rating.

Press to lock or unlock the rating.

Lock : Red

Unlock : Green

CANADIAN ENGLISH RATINGS CHART

E	Exempt - Exempt programming includes: news, sports, documentaries and other information programming, talk shows, music videos, and variety programming.
C	Programming intended for children under age 8. No offensive language, nudity or sexual content.
C8+	Programming generally considered acceptable for children 8 years and over. No profanity, nudity or sexual content.
G	General programming, suitable for all audiences.
PG	Parental Guidance suggested. Some material may not be suitable for children.
14+	Programming contains themes or content which may not be suitable for viewers under the age of 14. Parents are strongly cautioned to exercise discretion in permitting viewing by pre-teens and early teens.
18+	General programming, suitable for all audiences.

CANADIAN FRENCH RATINGS CHART

E	Exempt - Exempt programming.
G	General - Programming intended for audience of all ages. Contains no violence, or the violence content is minimal or is depicted appropriately.
8 ANS+	8+ General - Not recommended for young children. Programming intended for a broad audience but contains light or occasional violence. Adult supervision recommended.
13ANS+	Programming may not be suitable for children under the age of 13 - Contains either a few violent scenes or one or more sufficiently violent scenes to affect them. Adult supervision strongly suggested.
16ANS+	Programming may not be suitable for children under the age of 16 - Contains frequent scenes of violence or intense violence.
18ANS+	18+ ans Programming restricted to adults. Contains constant violence or scenes of extreme violence.

Menu Operations

This unit has a built in decoder that provides a visual depiction of the audio portion of a television program in the form of written words across the screen (white or colored letters on a black background). It allows you to read the dialogue of a television program or other information.

1



Press to select CLOSED CAPTION.

Press to display the CLOSED CAPTION screen.

Displays the On-Screen Closed Caption when the MUTE button is pressed. To delete the closed caption, press the MUTE button again.

2

INPUT LABEL

You can change the label of the video inputs to match with the connected device (VCR, DVD player etc.).

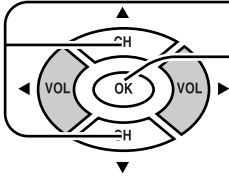
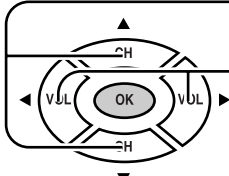
- 1  Press to select INPUT LABEL.
Press to display the INPUT LABEL screen.
- 2  Press to select the video input (VIDEO1, VIDEO2 or COMPONENT).
Press to select the INPUT LABEL. (VIDEO1/VIDEO2/COMPONENT, VCR, LD, GAME, DVD, DTV, SKIP* or [BLANK])

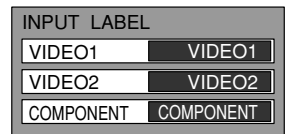
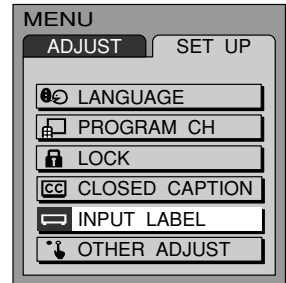

* Select to skip unused video input when pressing TV/VIDEO button.

OTHER ADJUST

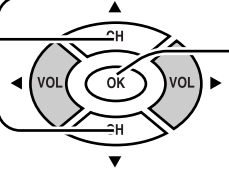
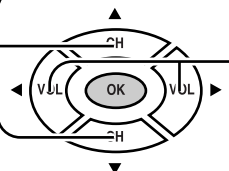
- 1  Press to select OTHER ADJUST.
Press to display the OTHER ADJUST screen.
- 2  Press to select the item.
Press to select the setting.

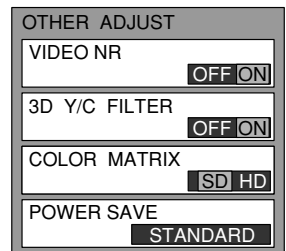
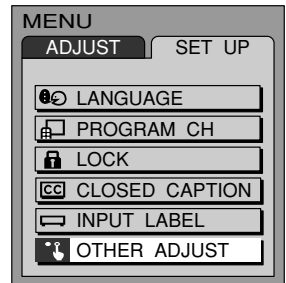

VIDEO NR

Reduce video noise in the picture.

OFF ↔ ON

3D Y/C FILTER

Minimizes noise and cross color in the picture. Not available for COMPONENT VIDEO INPUT and S-VIDEO INPUT.

OFF ↔ ON

COLOR MATRIX

Displays input signals (480p signals) in a natural color. Automatically adjusts color parameters for HD (high definition) and SD (standard definition).

SD ↔ HD

POWER SAVE

The POWER SAVE mode is suitable for watching television at night. Power consumption will be reduced.

STANDARD ↔ SAVING

PICTURE ADJUST

1

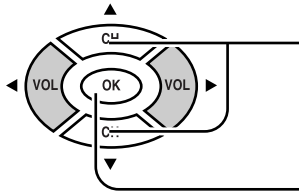

Press to select PICTURE ADJUST.

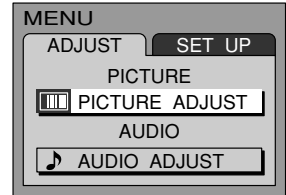

2

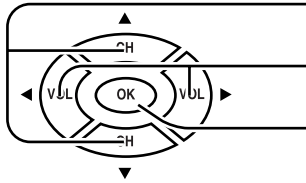

Press to select the sub-menu.

Adjust the setting watching the picture behind the menu.

Press to activate the setting if necessary.

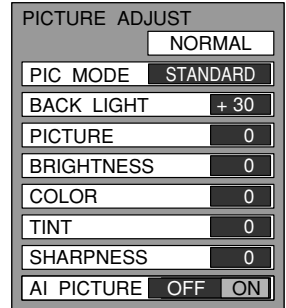

NORMAL/NORMALIZE

Select "NORMALIZE" and press "OK" button to return each PIC MODE to the factory default setting.

Notes:

- "NORMAL" means the PIC MODE is in the factory default setting. "NORMAL" changes to "NORMALIZE" when you change the setting of BACK LIGHT, PICTURE, BRIGHTNESS, COLOR, TINT, SHARPNESS or AI PICTURE.
- You can normalize each PIC MODE separately.

PIC MODE

The picture mode is stored for TV, VIDEO1, VIDEO2 and COMPONENT individually.

MODE	Function
VIVID	Displays a clear screen with high contrast.
STANDARD	Displays a standard image.
CINEMA	Ideal for watching movies in a dark room.

BACK LIGHT, PICTURE, BRIGHTNESS, COLOR, TINT, SHARPNESS, AI PICTURE

You can change the sub-menu settings (BACK LIGHT, PICTURE, BRIGHTNESS, COLOR, TINT, SHARPNESS and AI PICTURE) for each PIC MODE (STANDARD, CINEMA, and VIVID) according to your personal preference.

Sub-menu	Function
BACK LIGHT	Luminance of the back light is adjusted.
PICTURE	Selects proper brightness and density for the room.
BRIGHTNESS	Adjusts for easier viewing of dark pictures such as night scenes.
COLOR	Adjusts the level of color.
TINT	Adjusts for flesh tone color.
SHARPNESS	Adjusts the degree of sharpness.
AI PICTURE	Displays black and white more accurately when turned ON.

AUDIO ADJUST

1

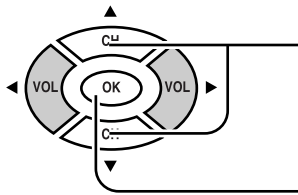

Press to select AUDIO ADJUST.

Press to display the AUDIO ADJUST screen.

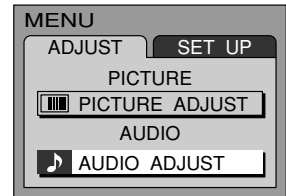

2

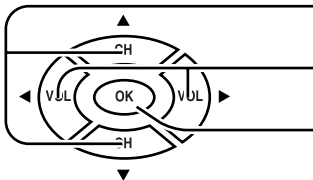

Press to select the sub-menu.

Select the setting listening to the sound.

Press to activate the setting if necessary.

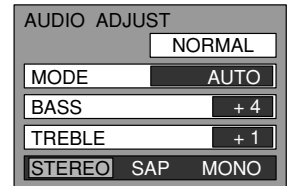

NORMAL/NORMALIZE

Select "NORMALIZE" and press "OK" button to return each MODE to the factory default setting.

Notes:

- "NORMAL" means the MODE is in the factory default setting. "NORMAL" changes to "NORMALIZE" when you change the setting of BASS or TREBLE.
- You can normalize each MODE separately.

MODE

MODE	Function
DYNAMIC	Gives contrast to sound.
MUSIC	For programs consisting mainly of music. Enhances high sounds (around 4 kHz).
AUTO	Automatically adjusts for a wide Dynamic Range.
STANDARD	Emits the original sound.

BASS, TREBLE

You can change the level of each sub-menu (BASS and TREBLE) for each MODE (AUTO, STANDARD, DYNAMIC and MUSIC) according to your personal preference.

Sub-menu	Function
BASS	Adjusts low frequencies.
TREBLE	Adjusts high frequencies.

STEREO/SAP/MONO

Note:

- Red display : With signal
White display : No signal
White display (All modes) : MONO
- To change the mode using SAP button (see page 13).

MODE	Function
STEREO	Two channel audio reception.
SAP	Second Audio Programming (typically used for bilingual audio).
MONO	Select when stereo signal is weak.

ASPECT Controls

(For Video input only)

This feature allows you to enjoy viewing the picture at its maximum size, including wide screen cinema format picture.

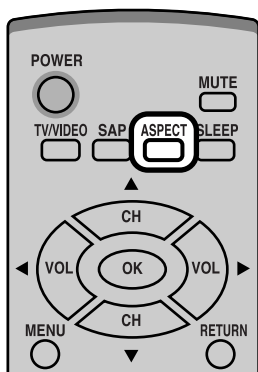

Each time you press the button:

4 : 3 ↔ 16 : 9

Notes:

- The aspect setting is stored separately for VIDEO1, VIDEO2 and COMPONENT.
- In TV mode, the aspect is fixed at 4:3.

Mode	Picture	Explanation
4 : 3		4:3 mode will display a 4:3 picture at its standard 4:3 size without any stretching.
16 : 9		16:9 mode will display 16:9 aspect ratio picture. Bars can be seen at the top and bottom of the image (not available in TV mode).

Manual de instrucciones [Resumen]

Estimado cliente de Panasonic

Bienvenido a la familia de clientes de Panasonic.

Esperamos sinceramente que disfrute durante muchos años de su nuevo Esperamos sinceramente que disfrute durante muchos años de su nuevo televisor LCD.

Para obtener el máximo beneficio de su aparato, lea estas instrucciones antes de hacer cualquier ajuste, y guárdelas para poder utilizarlas como referencia en el futuro.

Guarde también el recibo de su compra, y anote el número del modelo y el número de serie de su aparato en el espacio provisto en la cubierta posterior de estas instrucciones.

Instalación de las pilas del mando a distancia

Se necesitan dos pilas AA.

1. Abra la cubierta de las pilas.

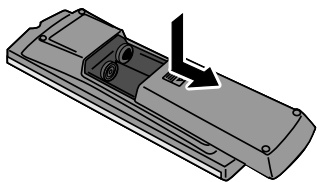

2. Instale las pilas y vuelva a poner la tapa. Tenga en cuenta las polaridades (+ y -) al instalar las pilas.

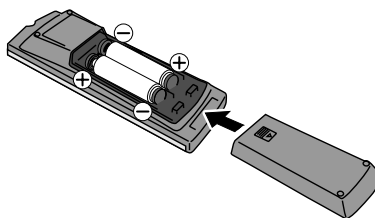

⚠ Precauciones relacionadas con la utilización de las pilas

La instalación incorrecta de las pilas puede causar fugas en las mismas que podrían estropear el transmisor de mando a distancia.

Tome las precauciones siguientes:

1. Utilice siempre pilas nuevas cuando reemplace las viejas.
2. No intente cargar, cortocircuitar, desarmar, calentar o quemar las pilas usadas.
3. Las pilas deberán cambiarse cuando el mando a distancia funcione esporádicamente o no pueda controlar esta unidad.

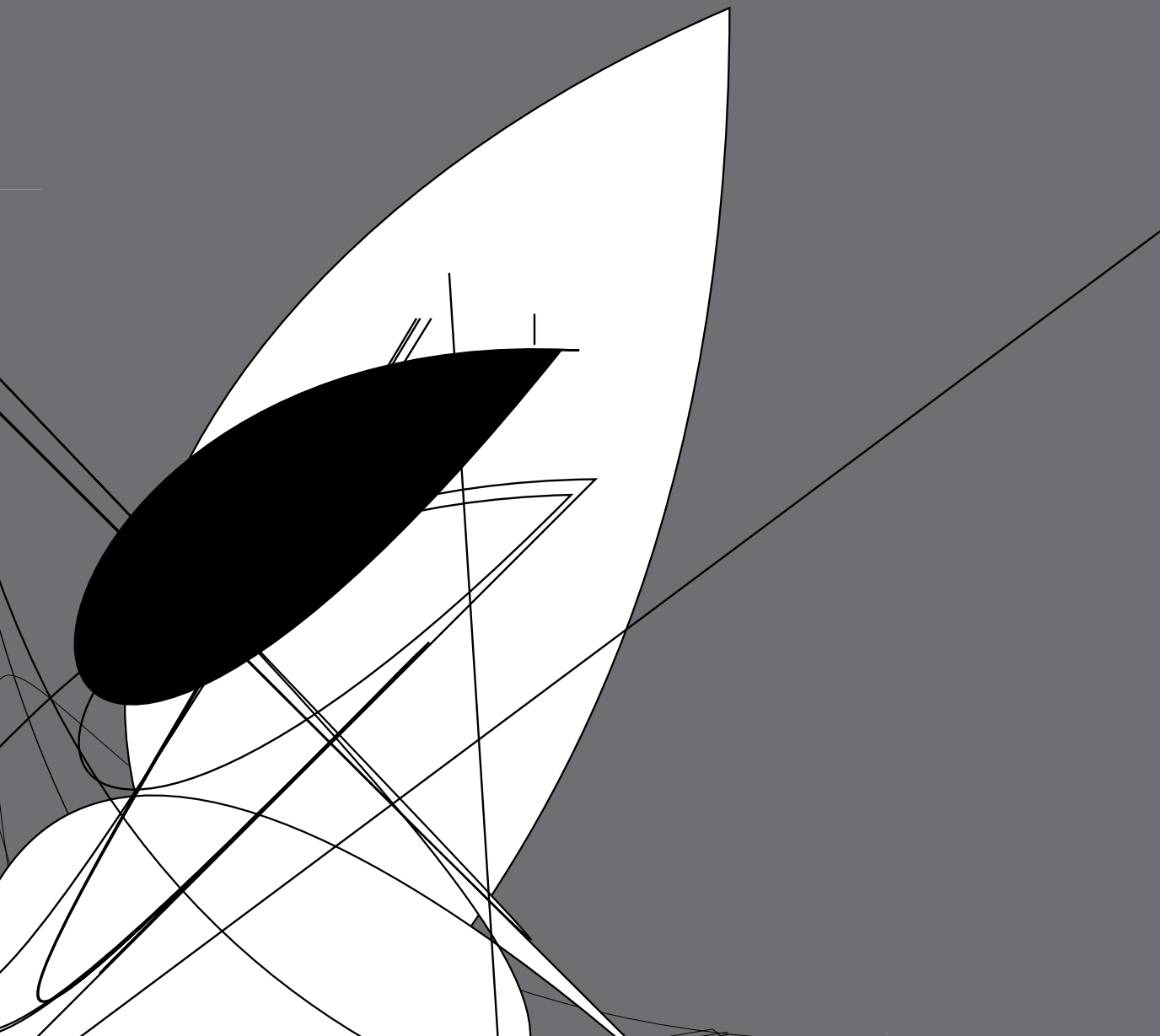

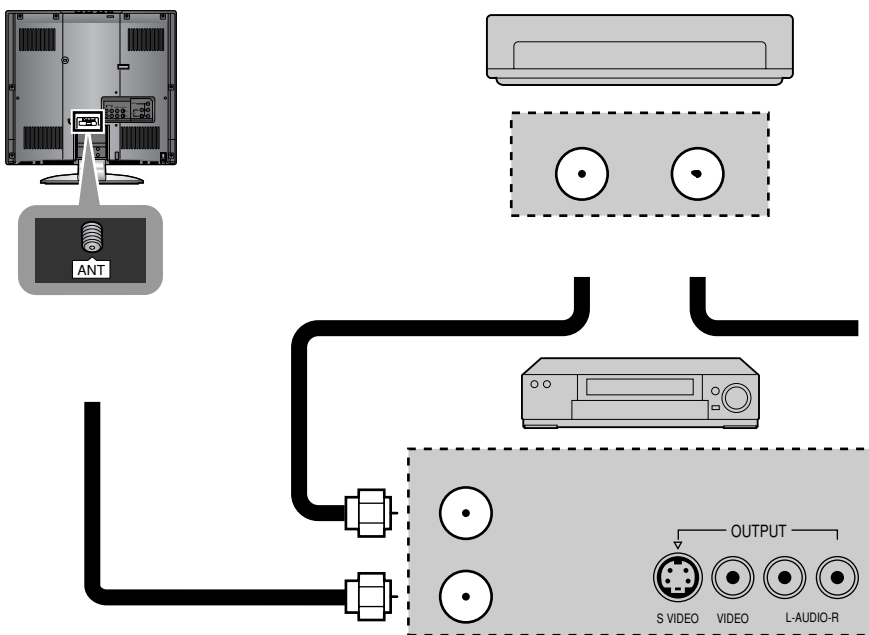
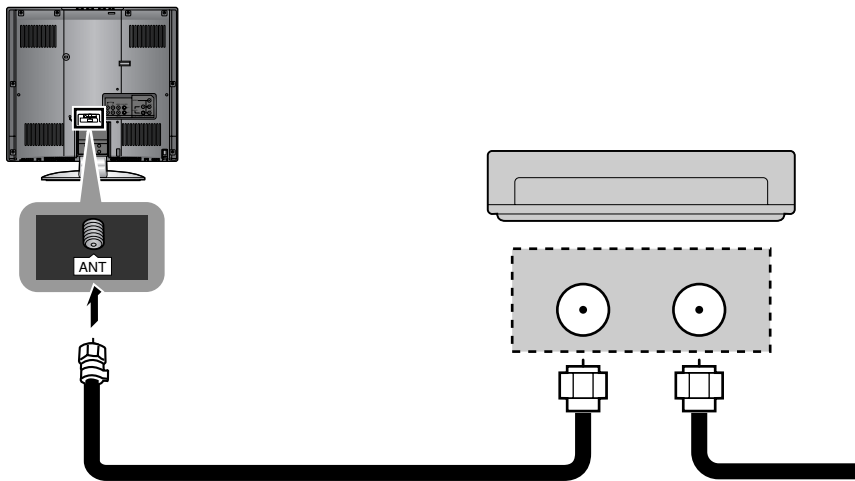

■ Para unir y atar los cables con la abrazadera [TC-20LA2]

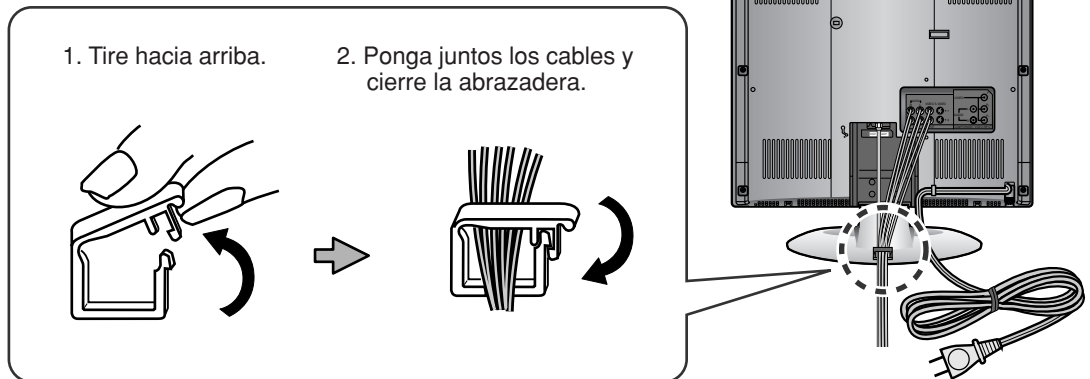

Nota:

- No ponga el cable de la antena y el cable de la alimentación juntos para evitar ruidos.

Conexión de auriculares

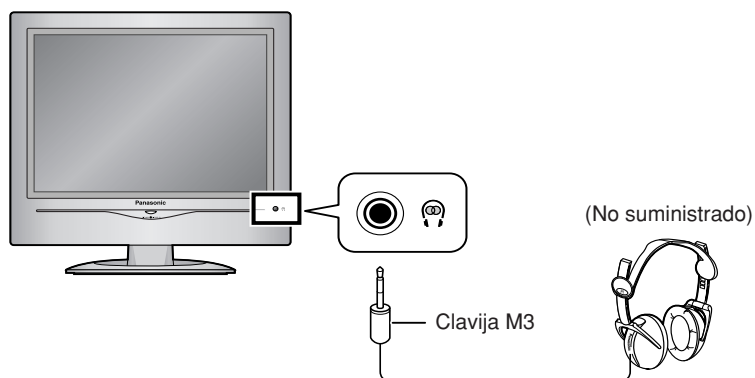

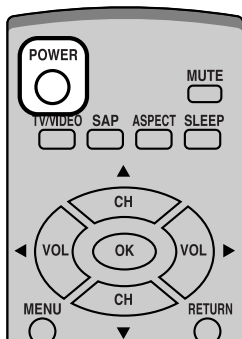

Controles básicos

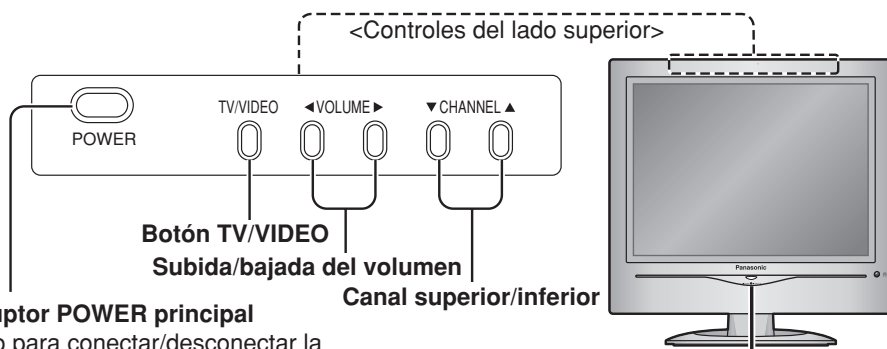

Interruptor POWER principal
Púselo para conectar/desconectar la alimentación principal del televisor (consulte la página 32).

Sensor de mando a distancia
Dentro de 20 pies (6 metros) a partir del panel delantero del televisor.

Botón MUTE
Púselo para silenciar el sonido.
Púselo de nuevo para cancelar el silenciamiento.
El silenciamiento se cancela cuando se desconecta la alimentación o se cambia en nivel del sonido.

Botón de la alimentación
Púselo para encender o apagar el televisor (consulte la página 32).
Nota:
Esto no funciona cuando la alimentación principal está desconectada (apagado).

Botón TV/VIDEO
Púselo para cambiar el modo de entrada.

Botón SAP
Púselo para seleccionar el modo de

Botón MENU
(consulte la página 34)

Botón RETURN
Púselo para volver a la pantalla anterior.

Botones numerados

Botón R-TUNE
Para cambiar a un canal o modo de vídeo anterior.

Botón ASPECT

Botón SLEEP
Ponga el tiempo tras el cual el televisor se pondrá en el modo de espera.

- Cuando queden 3 minutos parpadeará " 3" ("2" para 2 minutos y "1" para 1 minuto).
- El temporizador de cancelado se cancelará cuando se desconecte la alimentación.

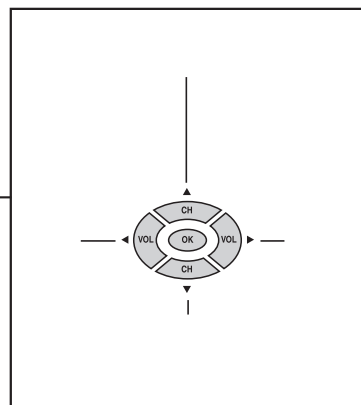
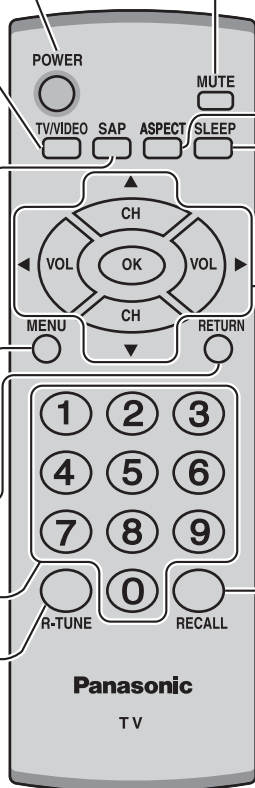

Botón RECALL
Púselo para visualizar el número del canal, el temporizador de cancelado y otras opciones.

Operaciones con menús

1

Púlselo para visualizar la pantalla MENU.

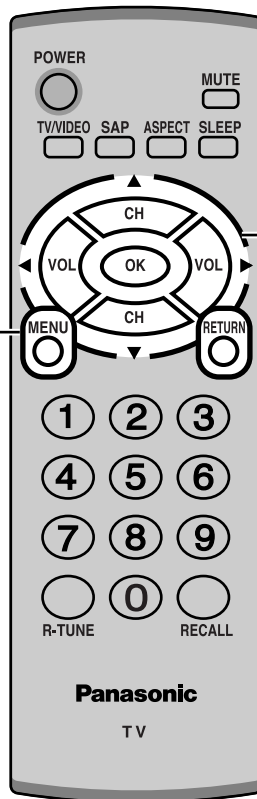
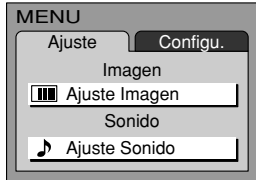

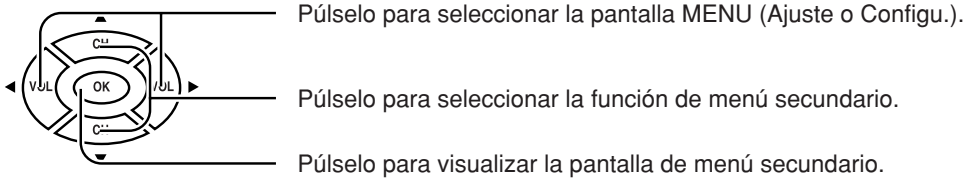

- Para volver a la pantalla anterior : RETURN
- Para salir de la pantalla MENU : MENU Con esto se retorna a la visión normal.

Ajuste Imagen	
	Normal
Imagen	Normal
Luz Posterior	+ 30
CONTRASTE	0
BRILLO	0
COLOR	0
TINTE	0
NITIDEZ	0
Imagen IA	No Si

Idioma	
Idioma	ESPAÑOL

Seleccione el idioma del menú.

ENGLISH	FRANÇAIS
ESPAÑOL	

Subtítulos	
EN MUDO	No
MODO	No

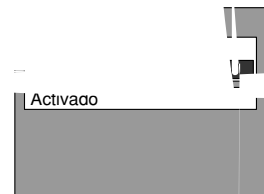

Sintonización de canales

1 Pulse el botón TV/VIDEO para visualizar el canal de TV.

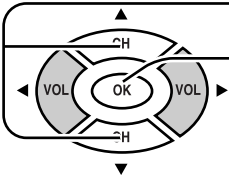
2  Pulse para seleccionar Prog. Canales.
Pulse para visualizar la pantalla Prog. Canales.

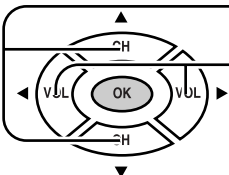

3  Pulse para seleccionar MODO.
Pulse para seleccionar TV o CABLE.

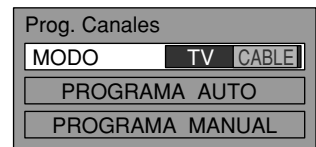

Programación automática de canales

Explora y guarda automáticamente todos los canales de TV.

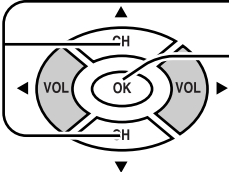
4  Pulse para seleccionar PROGRAMA AUTO.
Púselo para visualizar la pantalla PROGRAMA AUTO.

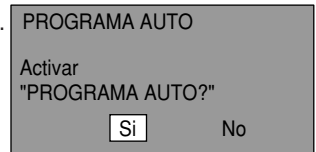

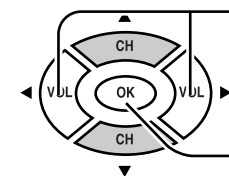
5  Púselo para seleccionar Si.
Púselo para iniciar PROGRAMA AUTO.

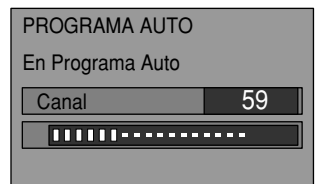

Los canales avanzarán automáticamente hasta que todos ellos hayan sido explorados. Los números de los canales con señal de video recibida se guardarán en la memoria de canales.

Notas:

- Cuando se pulse cualquier botón durante PROGRAMA AUTO, el televisor volverá a mostrar la imagen normal. (Los canales encontrados hasta ese punto se añaden.)
- Después de terminar PROGRAMA AUTO se visualizará el número del canal más bajo añadido.
- Cuando no haya canales que puedan recibirse, se visualizará el canal 69 (para TV) o el canal 125 (para TV por cable).





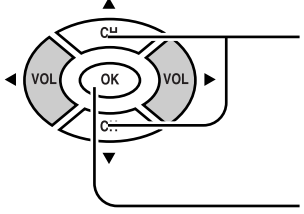
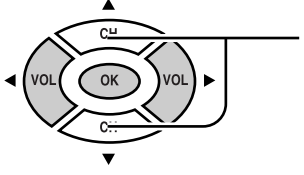
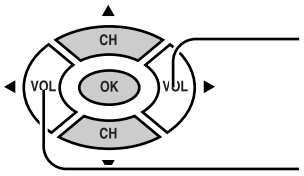











Programación automática de canales

Añada o borre un canal manualmente.

- 4**
- 
- Pulse para seleccionar PROGRAMA MANUAL.
- Pulse para visualizar la pantalla PROGRAMA MANUAL.
- | |
|-----------------|
| Prog. Canales |
| MODO TV CABLE |
| PROGRAMA AUTO |
| PROGRAMA MANUAL |
- | |
|-----------------|
| PROGRAMA MANUAL |
| Entre Canal |
| 121 |
- 5**
- 
- Pulse para seleccionar canal.
- También puede utilizar los botones numerados.
- 6**
- 
- Púselo para añadir el canal a la memoria de canales (el número del canal se pone de color azul).
- Púselo para borrar el canal de la memoria de canales (el número del canal se pone amarillo).
- Repita los pasos 5 y 6 para otros canales.

Troubleshooting

If there is a problem with your TV please refer to the table below to determine the symptoms, then carry out the suggested check. If this does not solve the problem, please contact your local Panasonic dealer, quoting the model number and serial number (both found on the rear of the TV).

Symptoms		Checks
Picture	Sound	
 Snowy Picture	 Noisy Sound	Antenna location, direction or connection
 Multiple Image	 Normal Sound	Aerial location, direction or connection
 Interference	 Noisy Sound	Electrical appliances Cars / Motorcycles Fluorescent lights
 Normal Picture	 No Sound	Volume level Sound mute switched on.
 No Picture	 No Sound	TV set to AV mode. Not plugged into AC outlet. Not switched on. Picture / Sound controls set at minimum levels. Check if in Standby mode.
 No Colour	 Normal Sound	Color controls set at minimum levels. Weak signal.
 Poor or Distorted Picture	 Weak or No Sound	Retune Channel (s).
 Normal Picture	 Weak or No Sound	Sound reception may have deteriorated. Switch STEREO mode (AUDIO ADJUST menu) to Off until reception improves.
Cannot operate with the remote control.		The battery is exhausted. The battery's polarity is wrong. The remote control sensor is exposed to strong light of a fluorescent lamp, etc.
The main unit is hot.		The main unit radiates heat and some of the parts may become hot. This is not a problem for performance or quality. Set up at a location with good ventilation. Do not cover the ventilation holes of the TV with a tablecloth etc., and do not place on top of other equipment.
There may be red spots, blue spots, green spots and black spots on the screen.		This is a characteristic of liquid crystal panels and is not a problem. The liquid crystal panel is built with very high precision technology giving you fine picture details. Occasionally, a few non-active pixels may appear on the screen as a fixed point of red, blue, green, or black. Please note this does not affect the performance of your LCD.

Specifications

	TC-20LA2	TC-20LA2D
Power Source	AC 120 V, 60 Hz	
Power Consumption	Average use : 65 W Stand-by condition : 0.11 W Power off : 0.08 W	
LCD	20-inch (510 mm), 4:3 aspect ratio LCD panel	
Screen Size	16.06 " (408.0 mm) (W) × 12.05 " (306.0 mm) (H)	
Channel Capability	VHF-12 : UHF-56 : Cable-125	
Sound		
Speaker	∅ 4 cm, 2 pcs, 16 Ω	
Headphones	M3 (3.5 mm) Jack × 1	
FEATURES		
	3D Y/C Digital Comb Filter	
	CLOSED CAPTION	V-Chip
Operating Conditions	Temperature : 41 °F - 95 °F (5 °C – 35 °C) Humidity : 5 % - 90 % RH (non-condensing)	
Connection Terminals		
INPUT	VIDEO (RCA PIN Type × 1) × 2	1.0 Vp-p (75 Ω)
	S-VIDEO (MINI DIN 4pin × 1) × 2	Y : 1 Vp-p (75 Ω), C : 0.286 Vp-p (75 Ω)
	AUDIO L-R (RCA PIN Type × 2) × 2	0.5 Vrms
COMPONENT VIDEO INPUT	Y	1.0 Vp-p (including synchronization)
	P _B / P _R	±0.35 Vp-p
	AUDIO L-R (RCA PIN Type × 2)	0.5 Vrms
Dimensions (W × H × D)		
Including TV Stand	19 39/64 " (498 mm) ×	19 39/64 " (498 mm) ×
	19 59/64 " (506 mm) ×	17 29/32 " (455 mm) ×
	10 9/32 " (260 mm)	7 31/64 " (190 mm)
TV Set Only	19 39/64 " (498 mm) ×	
	17 23/32 " (450 mm) ×	
	3 35/64 " (90 mm)	
Mass (Weight)	16.8 lb. (7.6 kg) Net	14.1 lb. (6.4 kg) Net

Note: Design and specifications are subject to change without notice. Weight and dimensions shown are approximate.

Customer' Record

The model number and serial number of this product can be found on its rear panel. You should note this serial number in the space provided below and retain this book, plus your purchase receipt, as a permanent record of your purchase to aid in identification in the event of theft or loss, and for Warranty Service purposes.

Model Number _____

Serial Number _____

**Panasonic Consumer Electronics
Company, Division of Matsushita
Electric Corporation of America**
One Panasonic Way Secaucus
New Jersey 07094

**Panasonic Sales Company,
Division of Matsushita Electric
of Puerto Rico Inc. ("PSC")**
Ave. 65 de Infanteria, Km 9.5
San Gabriel Industrial Park,
Carolina, Puerto Rico 00985

Panasonic Canada Inc.
5770 Ambler Drive
Mississauga, Ontario
L4W 2T3